

## Valvehead

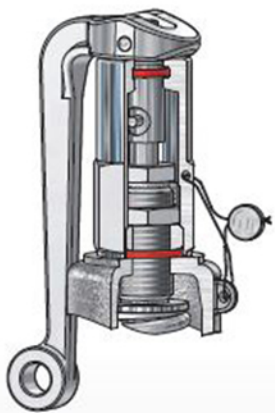

**Head A**  
(gaslight with easing lever)

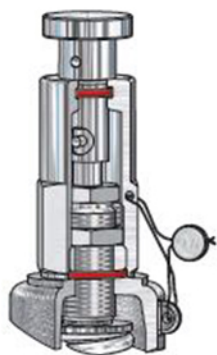

**Head B**  
(gaslight with lifting button)

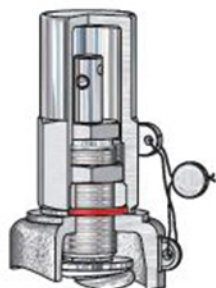

**Head C**  
(gaslight with cap)

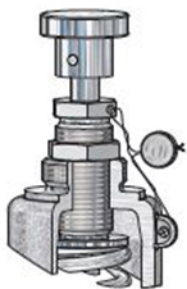

**Head D**  
(with lifting button)



**Head E**  
(with supported lifting button)

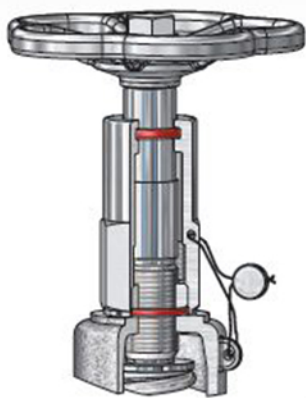

**Head F**  
(gaslight with handwheel)

## Valvehead



**Head G**  
(gaslight with handwheel  
and lifting button)

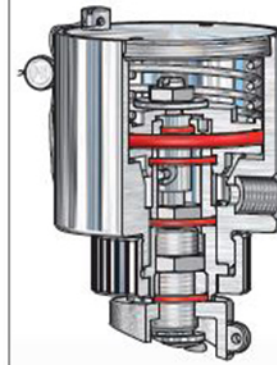

**Head H**  
(pneumatic lifting head)



**Head M**  
(manual lifting head)



**Head T**  
(sensor)

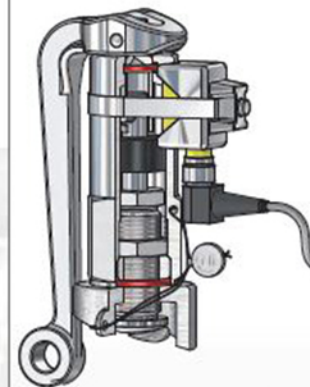

**Head AT**  
(sensor)

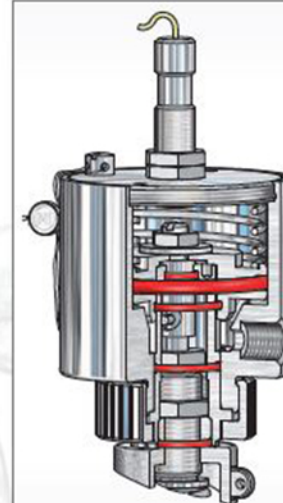

**Head HT**  
(sensor)